



**INSTYTUT TECHNIKI BUDOWLANEJ**

PL 00-611 WARSZAWA

ul. Filtrowa 1

tel.: (+48 22) 825-04-71

(+48 22) 825-76-55

fax: (+48 22) 825-52-86

[www.itb.pl](http://www.itb.pl)



Member of



[www.eota.eu](http://www.eota.eu)

## European Technical Assessment

**ETA-14/0450  
of 11/01/2016**

### General Part

**Technical Assessment Body issuing the European Technical Assessment**

Instytut Techniki Budowlanej

**Trade name of the construction product**

PESF

**Product family to which the construction product belongs**

Injection anchors for use in masonry

**Manufacturer**

Carina silicones Sp. z o.o.  
ul. Polna 14-18  
PL-55011 Siechnice  
Poland

**Manufacturing plant(s)**

Poland Factory 1

**This European Technical Assessment contains**

14 pages including 3 Annexes which form an integral part of this Assessment

**This European Technical Assessment is issued in accordance with regulation (EU) No 305/2011, on the basis of**

Guideline for European Technical Approval of "Metal injection anchor for use in masonry", ETAG 029, Edition April 2013 used as European Assessment Document (EAD)

**This version replaces**

ETA-14/0450 issued on 24/11/2014

*This European Technical Assessment is issued by the Technical Assessment Body in its official language. Translations of this European Technical Assessment in other languages shall fully correspond to the original issued document and shall be identified as such.*

*Communication of this European Technical Assessment, including transmission by electronic means, shall be in full. However, partial reproduction may only be made with the written consent of the issuing Technical Assessment Body. Any partial reproduction has to be identified as such.*

## Specific Part

### 1 Technical description of the product

The Injection system PESF is a bonded anchor (injection type) consisting of a mortar cartridge with PESF injection mortar, a perforated sleeve and an anchor rod with hexagon nut and washer size M10. The steel elements are made of zinc coated carbon steel.

The anchor rod is placed into a drilled hole filled with injection mortar and is anchored via the bond between steel element, injection mortar and masonry and mechanical interlock.

The illustration and the description of the product are given in Annex A.

### 2 Specification of the intended use in accordance with the applicable European Assessment Document (EAD)

The performances given in Annex C are only valid if the anchor is used in compliance with the specifications and conditions given in Annex B.

The provisions made in this European Technical Assessment are based on an assumed working life of the anchor of 50 years. The indications given on the working life cannot be interpreted as a guarantee given by the producer or Technical Assessment Body, but are to be regarded only as a means for choosing the right products in relation to the expected economically reasonable working life of the works.

### 3 Performance of the product and references to the methods used for its assessment

#### 3.1 Performance of the product

##### 3.1.1 Mechanical resistance and stability (BWR 1)

Essential characteristic	Performance
Characteristic resistance for tension and shear loads	Annex C1
Characteristic resistance for bending moments	Annex C1
Displacements under shear and tension loads	Annex C1
Reduction Factor for job site tests ( $\beta$ -Factor)	Annex C2
Edge distances and spacings	Annex C2

##### 3.1.2 Safety in case of fire (BWR 2)

Essential characteristic	Performance
Reaction to fire	Anchorage satisfy requirements for Class A1
Resistance to fire	No performance assessed

##### 3.1.3 Hygiene, health and the environment (BWR 3)

In addition to the clauses relating to dangerous substances contained in this European Technical Assessment, there may be other requirements applicable to the products falling within its scope (e.g. transposed European legislation and national laws, regulations and administrative provisions). In order to meet the provisions of



the regulation (EU) No 305/2011, these requirements need also to be complied with, when and where they apply.

### 3.1.4 Safety and accessibility in use (BWR 4)

For basic requirement safety in use the same criteria are valid as for basic requirement mechanical resistance and stability.

### 3.1.5 Sustainable use of natural resources (BWR 7)

No performance assessed.

### 3.1.6 General aspects relating to fitness for use

Durability and serviceability are only ensured if the specifications of intended use according to Annex B1 are kept.

## 3.2 Methods used for the assessment

The assessment of fitness of the anchor for the declared intended use in relation to the requirements for mechanical resistance and stability and safety in use in the sense of the Basic Requirements 1 and 4 has been made in accordance with the ETAG 029 "Metal injection anchor for use in masonry".

## 4 Assessment and verification of constancy of performance (AVCP) system applied, with reference to its legal base

According to the Decision 97/177/EC of the European Commission the system of assessment and verification of constancy of performance (see Annex V to Regulation (EU) No 305/2011) given in the following table is applied.

Product	Intended use	Level or class	System
Metal injection anchors for use in masonry	Fixing and/or support to masonry, structural elements (which contribute to the stability of the works) or heavy units such as cladding as well as installation	–	1

## 5 Technical details necessary for the implementation of the AVCP system, as provided in the applicable European Assessment Document (EAD)

Technical details necessary for the implementation of the AVCP system are laid down in the control plan deposited in Instytut Techniki Budowlanej.

For the type testing the results of the tests performed as part of the assessment for the European Technical Assessment shall be used unless there are changes in the production line or plant. In such cases the necessary initial type testing has to be agreed between Instytut Techniki Budowlanej and the notified body.

Issued in Warsaw on 11/01/2016 by Instytut Techniki Budowlanej

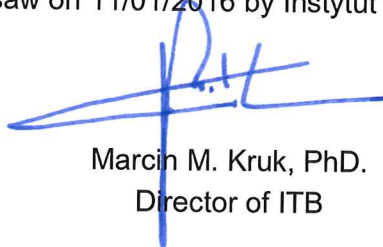

Marcin M. Kruk, PhD.  
Director of ITB

### Schema of the anchor in use

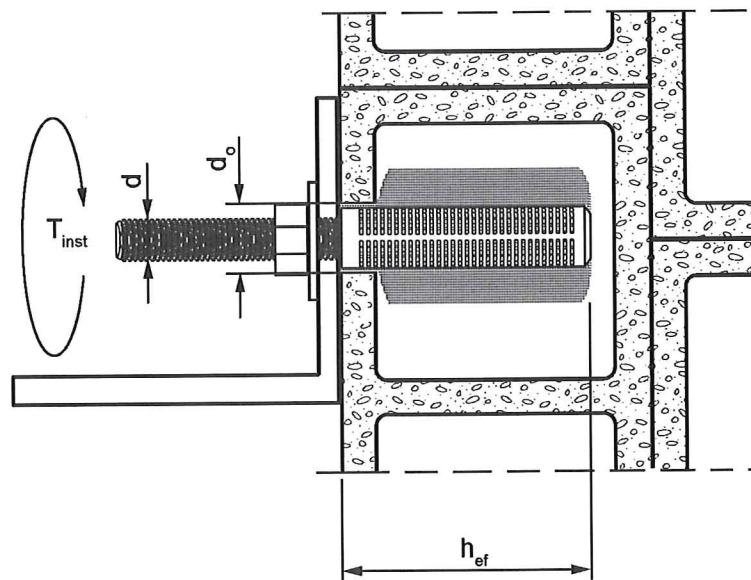







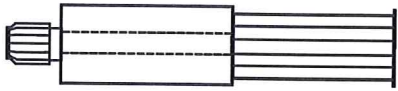

**PESF**

**Product description**  
Installation conditions

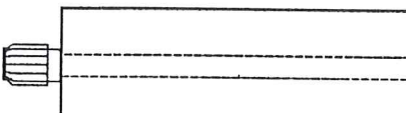
**Annex A1**  
of European  
Technical Assessment  
ETA-14/0450

**Mortar cartridges and applicator guns:**

	<b>Cartridge</b>	<b>Applicator gun</b>
coaxial cartridge: 150 ml		
side-by-side cartridge: 235 ml 345 ml 825 ml		
coaxial cartridge: 380 ml 400 ml 410 ml		
two-layers cartridge with plastic insert 150 ml 165 ml 170 ml 280 ml 300 ml 410 ml		

**Special mixing nozzle:**



<b>PESF</b>	<b>Annex A2</b> of European Technical Assessment ETA-14/0450
<b>Product description</b> Injection system	

**Anchor rods**

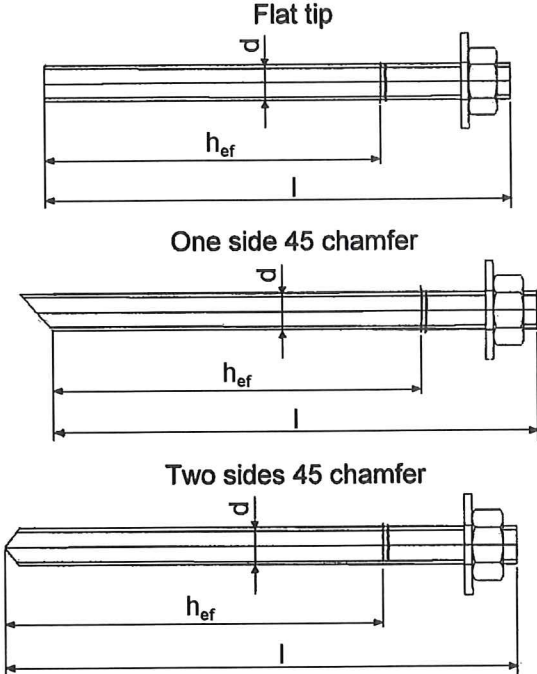

**Perforated plastic sleeve**

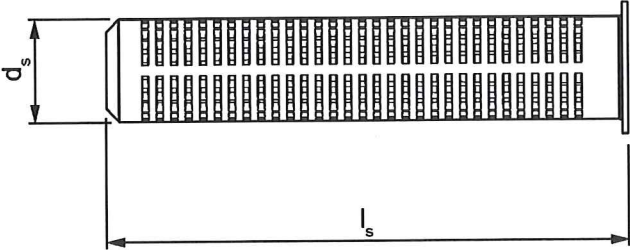

<b>PESF</b>	<b>Annex A3</b> of European Technical Assessment ETA-14/0450
<b>Product description</b> Threaded rods and sleeve	

**Table A1: Materials**

Part	Designation	Material
1	Chemical mortar	Polyester, styrene free resine mortar, hardener, additive
2	Anchor rod	Carbon steel class 5.8, EN ISO 898-1, zinc plated $\geq 5 \mu\text{m}$ , EN ISO 4042
3	Washer	Carbon steel, zinc plated $\geq 5 \mu\text{m}$ , EN ISO 4042
4	Hexagonal nut	Carbon steel class 5, EN ISO 898-2, zinc plated $\geq 5 \mu\text{m}$ , EN ISO 4042
5	Perforated sleeve	Polyethylene

**PESF**

**Product description**  
Materials

**Annex A4**  
of European  
Technical Assessment  
ETA-14/0450



**Specification of intended use**

**Anchorage subject to:**

- Static and quasi-static loads

**Base materials:**

- Perforated ceramic blocks (use category c), according to Annex B2.
- Mortar strength class of the masonry M2,5 at minimum according to EN 998-2:2010.
- For other perforated, ceramic blocks the characteristic resistance of the anchor may be determined by job site tests according to ETAG 029, Annex B under consideration of the  $\beta$ -factor according to Annex C2, Table C4.

**Temperature range:**

- Tb: -40°C to +80°C (max. short term temperature +80°C and max. long term temperature +50°C).

**Use conditions (Environmental conditions):**

- Structures subject to dry internal conditions (zinc coated steel).

**Use categories:**

- c base material.
- w/d installation and use.

**Design:**

- Verifiable calculation notes and drawings are prepared taking account the relevant masonry in the region of the anchorage, the loads to be transmitted and their transmission to the supports of the structure. The position of the anchor is indicated on the design drawings.
- The anchorages are designed in accordance with to the ETAG 029, Annex C, design method A under the responsibility of an engineer experienced in anchorages and masonry work.

**Installation:**

- Dry internal structures.
- Hole drilling by rotary drill mode.
- Anchor installation carried out by appropriately qualified personnel and under the supervision of the person responsible for technical matters of the site.

<b>PESF</b>	<b>Annex B1</b> of European Technical Assessment ETA-14/0450
<b>Intended use</b> Specifications	

**Table B1: Base material**

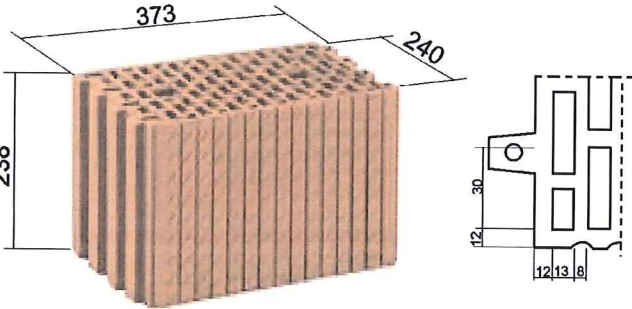
Type of base material	Standard
<p>Perforated ceramic blocks (LD) class <math>\geq 15</math></p> 	<p>EN 771-1</p>

<b>PESF</b>	<b>Annex B2</b> of European Technical Assessment ETA-14/0450
<b>Intended use</b> Type of brick and dimensions	

**Table B2: Installation parameters of anchor rods with perforated sleeves**

Size		M10
Size of rod	$d_{nom}$ [mm]	10
Size of sleeve	$d_s \times l_s$ [mm]	16 x 85
Drill hole diameter	$d_o$ [mm]	16
Depth of drilled hole to deepest point	$h_1$ [mm]	90
Effective anchorage depth	$h_{ef}$ [mm]	85
Torque moment	$T_{inst}$ [Nm]	4

**Table B3: Maximum processing times and minimum curing times of PESF resin mortar**

Masonry temperature [°C]	Maximum processing (working) time [Minutes]	Minimum curing (loading) time [Minutes]
-5	50	90
5	18	30
15	8	20
25	3	20
35	2	20

<b>PESF</b>	<b>Annex B3</b> of European Technical Assessment ETA-14/0450
<b>Intended use</b> Installation parameters, processing and curing times	

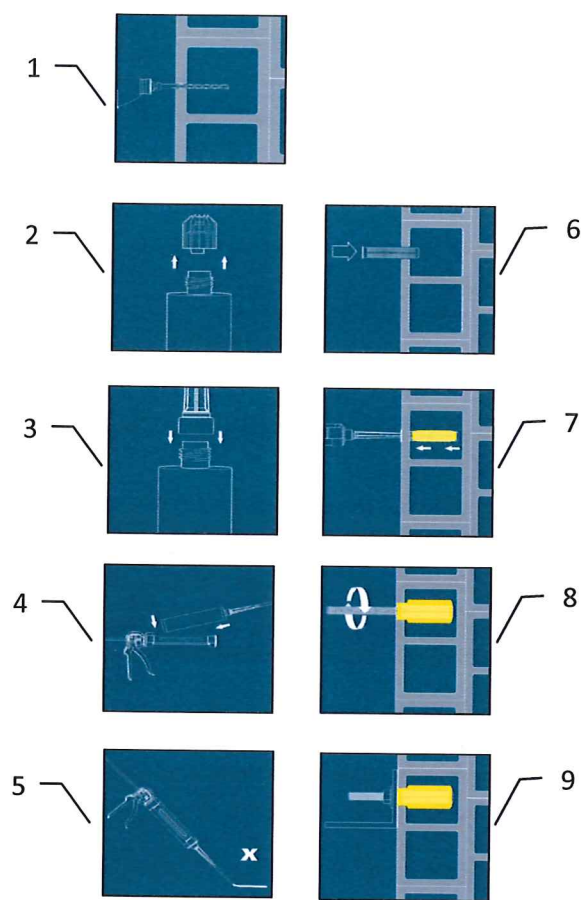

- 1 – Drill the hole using a rotary machine to the correct diameter and depth
- 2 – Remove the sealing cap
- 3 – Screw on the mixing nozzle
- 4 – Place the cartridge into the applicator gun
- 5 – Dispense the first part (~ 10 cm) to waste until an even color is achieved
- 6 – Introduce the sleeve
- 7 – Insert the nozzle to the end of the sleeve and inject the resin so long till the sleeve will fill into 100%
- 8 – Insert the anchor, slowly with a slight twisting motion into the sleeve
- 9 – Remove excess resin and leave the fixing until minimum curing (loading) time has elapsed

<b>PESF</b>	<b>Annex B4</b> of European Technical Assessment ETA-14/0450
<b>Intended use</b> Installation instruction	

**Table C1: Characteristic tension load and shear load values**

Brick parameters: Density $q$ [kg/m <sup>3</sup> ] Compressive strength $f_b$ [N/mm <sup>2</sup> ]	Sleeve	Anchor size	Effective anchorage depth $h_{ef}$ [mm]	Characteristic resistance $N_{Rk}$ [kN] <sup>1)</sup>	Characteristic resistance $V_{Rk}$ [kN] <sup>2), 3)</sup>
$q \geq 900$	16 x 85	M10	85	3,0	1,25
$f_b \geq 12$					
Partial safety factor $\gamma_M = 2,5$ <sup>4)</sup>					

1) For design according to ETAG 029, Annex C

$$N_{Rk} = N_{Rk,p} = N_{Rk,b} = N_{R,pb} = N_{Rk,s}$$

2) For design according to ETAG 029, Annex C

$$V_{Rk} = V_{Rk,b} = V_{Rk,c} = V_{Rk,s}$$

3)  $V_{Rk}$  calculated according to ETAG 029 (Edition April 2013), Annex C, Section C.5.2.2.5

4) In absence of other national regulations

**Table C2: Characteristic bending moment**

Characteristic bending moment	$M_{Rk,s}$ [Nm]	37,38
Partial safety factor	$\gamma_{Ms}$	1,25 <sup>1)</sup>

1) if no other national regulations exist

**Table C3: Displacements under tension and shear load**

N [kN]	$\delta_{NO}$ [mm]	$\delta_{N\infty}$ [mm]	V [kN]	$\delta_{VO}$ [mm]	$\delta_{V\infty}$ [mm]
1,3	0,09	0,15	2,5	0,8	2,5

<b>PESF</b>	<b>Annex C1</b> of European Technical Assessment ETA-14/0450
<b>Performances</b> Characteristic tension load and shear load values, characteristic bending moment, displacements	



**Table C4:  $\beta$ -factor for job site tests according to ETAG 029, Annex B**

Temperature	$\beta$ -factor
-40°C to 80°C	0,95 x 0,91 = 0,86

**Table C5: Edge distances and spacings**

Size $d_{nom} + \Phi d \times L$ [mm]	$s_{cr}$ [mm]	$s_{min}$ [mm]	$c_{min}$ [mm]
10 + $\Phi 16 \times 85$	$l_{unit, max}$	$l_{unit, max}$	$\geq 100$

$l_{unit, max}$  – maximal length of masonry unit

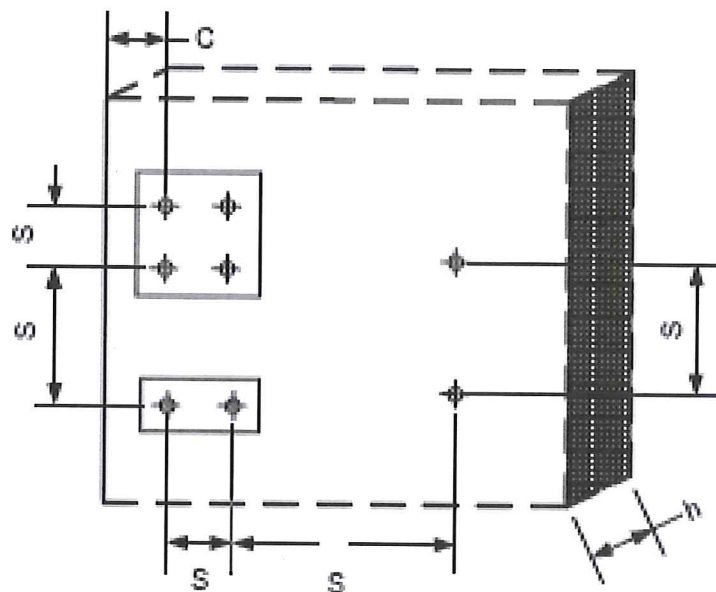

**PESF**

**Performances**  
 $\beta$ -factor, edge distances and spacings

**Annex C2**  
of European  
Technical Assessment  
ETA-14/0450